

Technical dimension / data sheet

MIWE condo e⁺

Unit version 2.5 | Type CO4.1208

► Components

- Base frame
- Oven module
- Steam Hood



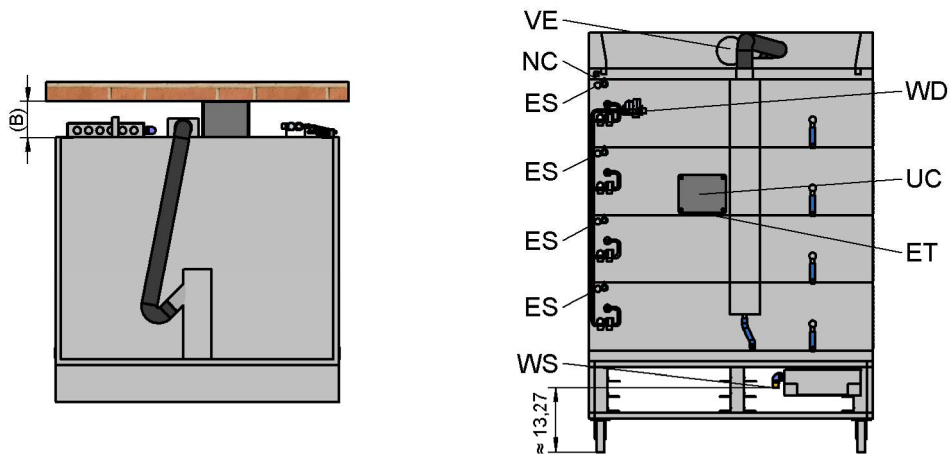
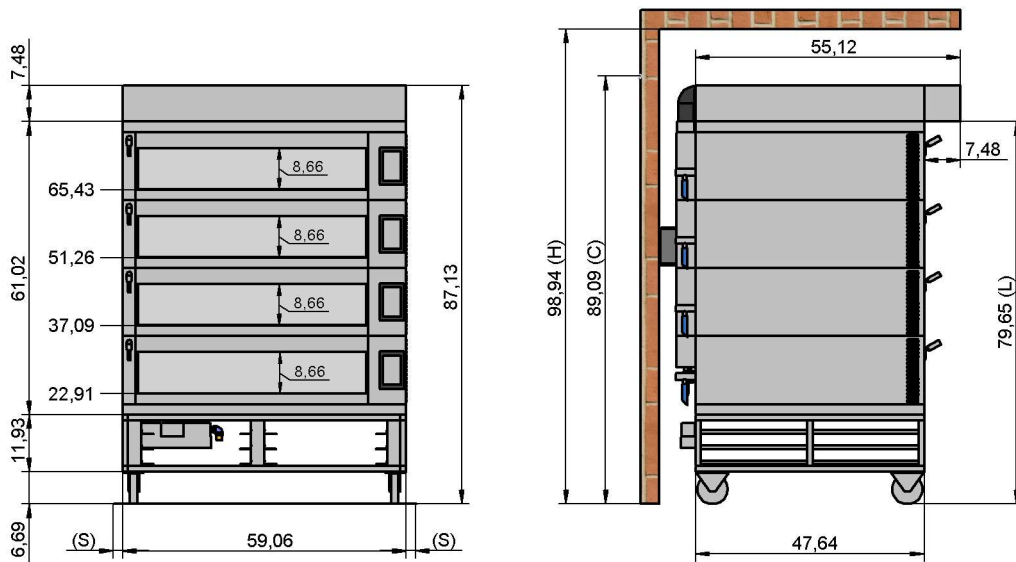

(10000024208_000_00_MDB)

May vary slightly from the actual version supplied.
All values in inch



Symbol	General points	
VE	Vapour hood extraction, for pipe (inside diameter)	Ø 5,984 inch
SD	Steam discharge connection, at side or top, for pipe (inside diameter)	-
	Required minimum clearance from the wall:	
S	At the side	1,181 inch
B	At the back with/without fuse box	- / 4,331 inch
L	Vapour hood bottom edge	See drawing
	Additional health and safety requirements apply for values below 74,80 inch	
C	Required clearance	See drawing
H	Minimum ceiling height	See drawing
	Minimum depth for access to the point of installation upon removal of all removable parts	50,630 inch
	Minimum width for access to the point of installation	59,449 inch
	Total weight without baking trays	approx. 2116,416 lb
NC	Network connection, number and position dependent on model	
	Power supply	
	Individual supply lines per component:	
	Oven module fuses	for 208V, 3/-/PE, 60 HZ
	per single baking chamber	3x30 A
	per double baking chamber	-
	Connected load of oven module:	
ES	per single baking chamber with/without steam device	7,800 kW / 6,400 kW
ED	per double baking chamber with/without steam device	-
EP	Electrical connection proofing cabinet (single supply line):	
	Connected load	-
	Fuses	-
UC	With MIWE fuse box (optional):	
ET	Total connected load	-
	Total fuses	-
	Water system	
WD	Drinking water connection, external thread	G3/4"
WS	Siphon, external thread	R3/4"
WP	Proofing cabinet condensate drain, outside diameter	-
	Water drain (provided by owner-operator)	Ø 1,969 inch

NOTE!

For additional information, please see quote or order confirmation and essential preparations.
These documents must be observed.

***UL-compliant**

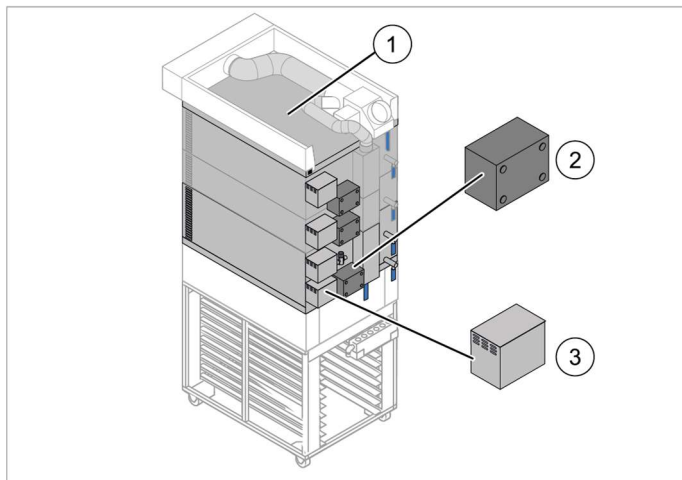

- ① Complete unit (example)
- ② Supply box, according to UL
 - One supply box is installed per deck
 - The connection at the supply box must be on the owner-operator side
 - Required minimum clearance from the back wall 5,91 inch
- ③ Additional water system cover

Certification



This dimension and data sheet is the property of MIWE Michael Wenz GmbH and is protected by copyright. Its contents may not be passed on, reproduced, utilised or disclosed without our explicit consent. Parties breaching this provision shall be liable for damages. All rights reserved in the event of the registration of industrial property rights.