

Owner's Manual

HEAVY DUTY COMMERCIAL MICROWAVE OVEN
[1.0 Cubic Foot (28 Liter)]

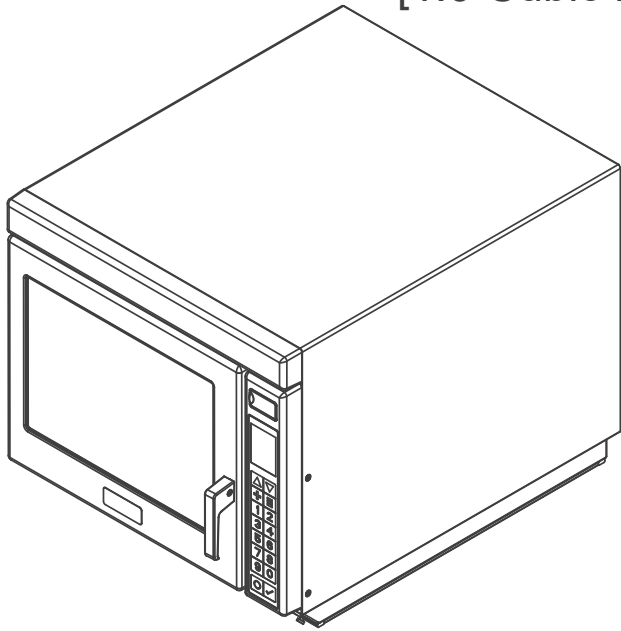

STYLE 1

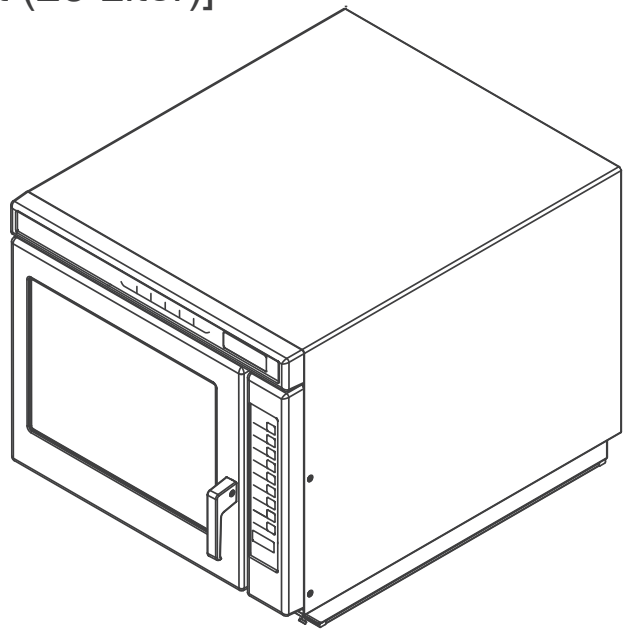

STYLE 2

Keep these instructions for future reference. If the equipment changes ownership, be sure this manual accompanies equipment. Please refer to the SAFETY INSTRUCTIONS for important safety information prior to using this oven

TABLE OF CONTENTS

Model Identification.....	2
Online Oven Resources	2
Important Safety Instructions.....	3
Grounding & Installation.....	6
Style 1	
Oven & Control Panel Features.....	7
Cooking & Programming Features	8
General Oven Operation	9
Operating Preset Recipe Keypads	10
Manual Cook Mode	11
Edit Recipe Screens	12
Edit Recipe Mode	13
Edit Recipe Mode: Folders	14
USB Flash Drive	15
User Options.....	16
Style 2	
Oven & Control Panel Features.....	17
Cooking & Programming Features	18
Displays	19
Basic Operation & Cooking	20
Programming	21
User Options.....	22
Cooking Instructions.....	23
Care & Cleaning.....	24
Before Calling for Service.....	25

Model Identification

When contacting ACP, provide product information. Product information is located on oven serial plate. Record the following information:

Model Number: _____
Manufacturing Number: _____
Serial or S/N Number: _____
Date of purchase: _____
Dealer's name and address: _____

Keep a copy of sales receipt for future reference or in case warranty service is required.

Any questions or to locate an authorized ACP servicer, call ACP ComServ Service Support.

- **Inside** the U.S.A. or Canada, call toll-free at 1-866-426-2621.
- **Outside** the U.S.A. and Canada, call +1-319-368-8195.
- **Email:** commercialservice@acpsolutions.com

Warranty service must be performed by an authorized ACP servicer. ACP also recommends contacting an authorized ACP servicer, or ACP ComServ Service Support if service is required after warranty expires.



Before using your oven, please take the time to read the Safety Instructions which shipped with the oven.

Information herein is subject to change without notice. Errors are subject to correction. For the most recent product literature, please visit acpsolutions.com/product-literature/

Online Oven Resources

ACP PROGRAMMING APPLICATION

Note: ACP Programming Application is compatible with 'Style 1' models.



Download and install the ACP Programming Application to create, edit, and customize menu and settings for your oven, using a desktop computer or tablet.

To download the latest and greatest version of the ACP Programming Application please visit acpsolutions.com/oven-programming/

PRECAUTIONS TO AVOID POSSIBLE EXPOSURE TO EXCESSIVE MICROWAVE ENERGY

- A. **DO NOT** attempt to operate this oven with the door open since open door operation can result in harmful exposure to microwave energy. It is important not to defeat or tamper with the safety interlocks.
- B. **DO NOT** place any object between the oven front face and the door or allow soil or cleaner residue to accumulate on sealing surfaces.
- C. **DO NOT** operate the oven if it is damaged. It is particularly important that the oven door close properly and that there is no damage to the:
 - 1. door (bent)
 - 2. hinges and latches (broken or loosened)
 - 3. door seals and sealing surfaces.
- D. The oven should not be adjusted or repaired by anyone except properly qualified service personnel.

SAVE THESE INSTRUCTIONS

IMPORTANT SAFETY INSTRUCTIONS

WARNING

To reduce the risk of burns, electrical shock, fire, or personal injury when using electrical equipment, basic safety precautions should be followed.

1. **READ** all instructions before using equipment.
 2. **READ AND FOLLOW** the specific “**PRECAUTIONS TO AVOID POSSIBLE EXPOSURE TO EXCESSIVE MICROWAVE ENERGY**” on page 1.
 3. This equipment **MUST BE GROUNDED**. Connect only to properly **GROUNDED** outlet. See “**GROUNDED/ EARTHING INSTRUCTIONS**” on page 4.
 4. Install or locate this equipment **ONLY** in accordance with the installation instructions in this manual.
 5. Some products such as whole eggs and sealed containers—for example, closed glass jars—are able to explode and **SHOULD NOT** be **HEATED** in this oven.
 6. Use this equipment **ONLY** for its intended use as described in this manual. Do not use corrosive chemicals or vapors in this equipment. This type of oven is specifically designed to heat, cook, or dry food. It is not designed for industrial or laboratory use.
 7. **HOT CONTENTS CAN CAUSE SEVERE BURNS. DO NOT ALLOW CHILDREN TO USE THE MICROWAVE.** Use caution when removing hot items
 8. **DO NOT** operate this equipment if it has a damaged cord or plug, if it is not working properly, or if it has been damaged or dropped.
 9. This equipment, including power cord, must be serviced **ONLY** by qualified service personnel. Special tools are required to service equipment. Contact nearest authorized service facility for examination, repair, or adjustment.
 10. **DO NOT** cover or block filter (if applicable) or other openings on equipment.
 11. **DO NOT** store this equipment outdoors. **DO NOT** use this product near water – for example, near a kitchen sink, in a wet basement, a swimming pool, or a similar location.
 12. **DO NOT** immerse cord or plug in water.
 13. Keep cord **AWAY** from **HEATED** surfaces.
 14. **DO NOT** let cord hang over edge of table or counter.
 15. See door cleaning instructions on page 4. Cleaning and user maintenance shall not be made by children without supervision.
 16. To avoid risk of fire in the oven cavity:
 - a. **DO NOT** overcook food. Carefully attend oven when paper, plastic, or other combustible materials are placed inside the oven to facilitate cooking.
 - b. Remove wire twist-ties from paper or plastic bags before placing bag in oven.
 - c. If materials inside the oven ignite, keep oven door **CLOSED**, turn oven off and disconnect the power cord, or shut off power at the fuse or circuit breaker panel.
 - d. **DO NOT** use the cavity for storage. **DO NOT** leave paper products, cooking utensils, or food in the cavity when not in use.
 17. For commercial use only.
 18. It is hazardous for anyone other than a competent person to carry out any service or repair operation that involves the removal of any cover which gives protection against exposure to microwave energy.
 19. If the door or door seals are damaged, the oven must not be operated until it has been repaired by a competent person.
 20. Appliance is not to be used by children 8 years and below or persons with reduced physical, sensory or mental capabilities or lack of experience and knowledge, unless they have been given supervision or instruction.
 21. Children being supervised not to play with appliance.
 22. Only use utensils that are suitable for use in microwave oven.
 23. When heating food in plastic or paper containers, keep an eye on the oven due to the possibility of ignition.
 24. If smoke is observed, switch off or unplug the appliance and keep the door closed in order to stifle any flames.
 25. Failure to maintain the oven in a clean condition could lead to deterioration of the surface that could adversely affect the life of the appliance and possibly result in a hazardous situation.
 26. The appliance should not be cleaned with a water jet or steam cleaner.
 27. Liquids or other foods must not be heated in sealed containers since they are liable to explode.
 28. Microwave heating of beverages can result in delayed eruptive boiling, therefore care must be taken when handling the container.
- Combination Ovens Only:**
29. **DO NOT** insert oversized foods or oversized utensils in a microwave/convection oven as they may create a fire, an electrical arc, or risk of electrical shock.
 30. **DO NOT** clean with metal scouring pads. Pieces can break off the pad and touch electrical parts involving risk of electrical shock.
 31. **DO NOT** use paper products not intended for high temperature cooking when equipment is operated in convection or combination mode.
 32. **DO NOT** store any materials, other than manufacturer’s recommended accessories, in this equipment when not in use.
 33. **DO NOT** cover any part of the oven with metal foil. Airflow restriction will cause overheating of the oven.
 34. **DO NOT** spray oven cleaning solutions toward the rear inner cavity surface. This will contaminate and damage the convection heating assembly.

SAVE THESE INSTRUCTIONS

IMPORTANT SAFETY INSTRUCTIONS



To avoid risk of personal injury or property damage, observe the following safety instructions:

General Use:

1. **Do not** use regular cooking thermometers in oven. Most cooking thermometers contain mercury and may cause an electrical arc, malfunction, or damage to oven.
2. Never use paper, plastic, or other combustible materials that are not intended for cooking.
3. When cooking with paper, plastic, or other combustible materials, follow manufacturer's recommendations on product use.
4. **Do not** use paper towels which contain nylon or other synthetic fibers. Heated synthetics could melt and cause paper to ignite.
5. To avoid surface deterioration, keep the oven in a clean condition. Infrequent cleaning could adversely affect the life of the appliance and possible result in a hazardous situation.
6. Clean oven regularly and remove any food deposits.

Heating Foods and Liquids:

7. Liquids such as water, coffee, or tea are able to be overheated beyond the boiling point without appearing to be boiling due to surface tension of the liquid. Visible bubbling or boiling when the container is removed from the microwave oven is not always present. **THIS COULD RESULT IN VERY HOT LIQUIDS SUDDENLY BOILING OVER WHEN A SPOON OR OTHER UTENSIL IS INSERTED INTO THE LIQUID.** To reduce the risk of injury to persons:
 - a. Do not overheat the liquid.
 - b. Stir the liquid both before and halfway through heating it.
 - c. Do not use straight-sided containers with narrow necks.
 - d. After heating, allow the container to stand in the microwave for a short time before removing it.
 - e. Use extreme care when inserting a spoon or other utensil into the container.
8. **Do not** deep fat fry in oven. Fat could overheat and be hazardous to handle.
9. **Do not** cook or reheat eggs in shell or with unbroken yolk using microwave energy. Pressure may build up and erupt. Pierce yolk with fork or knife before cooking.
10. Pierce skin of potatoes, tomatoes, and similar foods before cooking with microwave energy. When skin is pierced, steam escapes evenly.
11. **Do not** heat sealed containers or plastic bags in oven. Food or liquid could expand quickly and cause container or bag to break. Pierce or open container or bag before heating.

12. **Do not** heat baby bottles in oven.
13. Baby food jars shall be open when heated and contents stirred or shaken before consumption, in order to avoid burns.
14. Never use oven to heat alcohol or food containing alcohol as it can more easily catch fire if overheated.

Additional Microwave Oven Safety Instructions:

15. **Do not** operate equipment without load or food in oven cavity.
16. Use only popcorn in packages designed and labeled for microwave use. **Popping time varies depending on oven wattage.** Do not continue to heat after popping has stopped. Popcorn will scorch or burn. Do not leave oven unattended.
17. **Do not** use metal utensils in oven.
18. An authorized servicer **MUST** inspect equipment annually. Record all inspections and repairs for future use.

Additional Combination Oven Safety Instructions:

19. **Do not** pop popcorn in this oven.
20. **Do not** use metal utensils in oven except when recommended by microwave food manufacturers or recipe requires metal utensils in convection or combination mode. Heat food in containers made of glass or china if possible.
21. Oven temperature is at least 450°F in convection mode. Verify plastic, paper or other combustible materials are recommended by the manufacturer to withstand the maximum oven temperature.
22. Racks, utensils, rack guides, and oven surfaces may become hot during or after use. Use utensils or protective clothing, like pan grips or dry oven mitts, when necessary to avoid burns.
23. **Do not** unplug oven immediately after use. Internal fan must cool oven to avoid damage of electrical components.
24. Caution: To avoid burns, do not use containers loaded with liquid or kitchen products that become liquid by heating at levels above those that can be easily observed.

SAVE THESE INSTRUCTIONS

Grounding & Installation

Grounding/Earthing Instructions

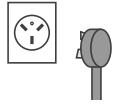

Oven MUST be grounded. Grounding reduces risk of electric shock by providing an escape wire for the electric current if an electrical short occurs. This oven is equipped with a cord having a grounding wire with a grounding plug. The plug must be plugged into an outlet that is properly installed and grounded.

Consult a qualified electrician or servicer if grounding instructions are not completely understood, or if doubt exists as to whether the oven is properly grounded.

DO NOT use an extension cord.

If the product power cord is too short, have a qualified electrician install a three-slot receptacle. This oven should be plugged into a separate circuit with the electrical rating as provided in product specifications (available at www.acpsolutions.com) and the oven's serial plate / rating label. When the oven is on a circuit with other equipment, an increase in cooking times may be required and fuses can be blown.

EXTERNAL EQUIPOTENTIAL EARTHING TERMINAL (*export only*)

Equipment has secondary earthing terminal. Terminal provides external earthing connection used in addition to earthing prong on plug. Located on outside of oven back, terminal is marked with symbol shown at right



Installation

Unpacking Oven

- Inspect oven for damage such as dents in door or inside oven cavity.
- Report any dents or breakage to source of purchase immediately.
DO NOT attempt to use oven if damaged.
- Remove all packing materials from oven interior.
- If oven has been stored in extremely cold area, wait a few hours before connecting power.

Radio Interference

Microwave operation may cause interference to radio, television. Reduce or eliminate interference by doing the following:

- Clean door and sealing surfaces of oven according to instructions in "Care & Cleaning" section.
- Place radio, television, etc. as far as possible from oven.
- Use a properly installed antenna on radio, television, etc. to obtain stronger signal reception.

Oven Placement

- DO NOT install oven next to or above source of heat, such as pizza oven or deep fat fryer. This could cause oven to operate improperly and could shorten life of electrical parts.
- DO NOT block or obstruct oven filters. Allow access for cleaning.
- Install oven on clean, flat, and level counter-top surface.
- If provided, place warning label in a conspicuous place close to oven.
- Outlet should be located so that plug is accessible when oven is in place.
- This oven is required to be sealed to the countertop to establish proper sanitary operation. It is manufactured with a basepan gasket designed to provide this seal.
- Inspect gasket for damage before placing oven on countertop.
- Minimize sliding of oven to prevent damage to gasket.
- When in place, this gasket is intended to prevent liquid spillage on adjacent countertop surfaces from passing under inaccessible portions off the equipment.

OVEN CLEARANCES

- A. Allow at least 2" (5.1 cm) of clearance around top of oven. Proper air flow around oven cools electrical components. With restricted air flow, oven may not operate properly and life of electrical parts is reduced.
- B. There is not an installation clearance requirement for the back of the oven.
- C. Allow at least 1" (2.54 cm) of clearance around sides of oven.
- D. Install oven so oven bottom is at least 3 feet (91.5 cm) above floor.

WARNING

To avoid risk of electrical shock or death, this oven must be grounded and plug must not be altered.

WARNING

Excessive Weight Hazard

Use two or more people to move and install oven. Failure to do so can result in back or other injury

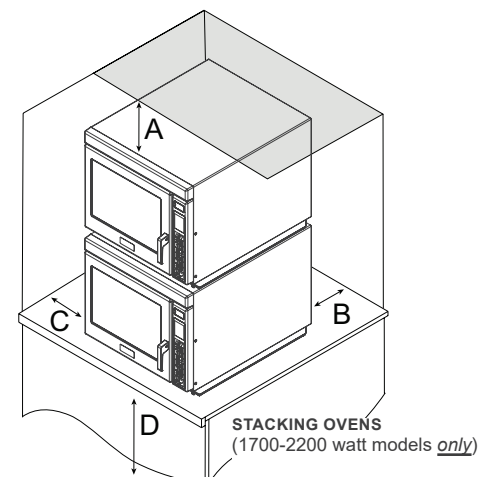
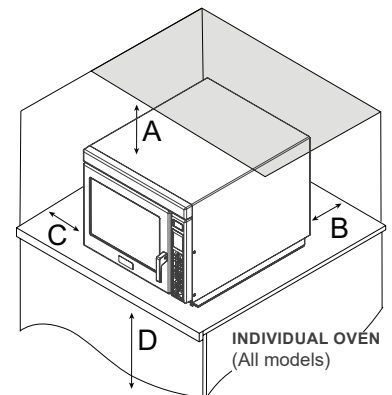

Note: There are multiple styles of controls. Choose the control that matches unit. Control panel coloring may vary by model

Oven Features

- (1) **USB PORT / PROTECTIVE COVER**
- (2) **DISPLAY**
- (3) **CONTROL PANEL**
- (4) **DOOR HANDLE**
Ergonomically designed for one handed "Lift and Pull" operation.
- (5) **AIR INTAKE FILTER (not pictured)**
Removable and cleanable air intake filter.
- (6) **UNIT SERIAL NUMBER (not pictured)**
Located inside the door and on the lower-right-side of the oven.

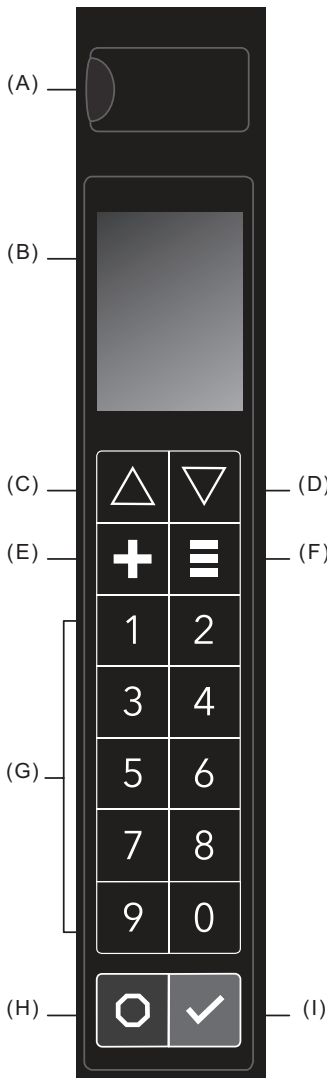
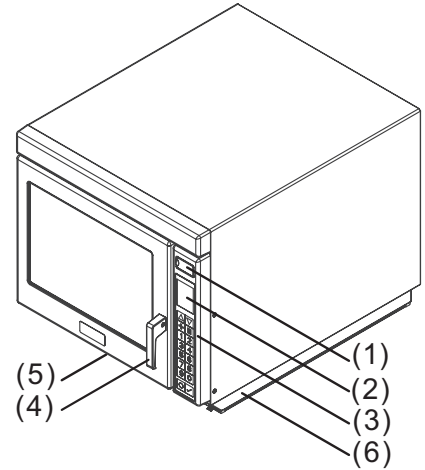

Control Panel Features

- (A) **USB PORT**
Standard USB flash drive compatible. Allows for import/export of recipes and user options, and to update firmware.
- (B) **DISPLAY**
2.8" (71 mm) Color LCD Display.
- (C) **UP KEYPAD**
Scrolls up through editable fields and pages.
- (D) **DOWN KEYPAD**
Scrolls down through editable fields and pages.
- (E) **X2 QUANTITY KEYPAD**
Increases a preset cook time by adding a percentage of the original cook time, also known as a **cook factor**. Used for cooking multiple servings of foods.
- (F) **MENU KEYPAD**
Opens Main Menu screen to access features including: edit recipes; manual cook mode; adjust date/time settings; change user options; load menu files; and/or enter service mode.
- (G) **NUMBER KEYPADS**
Used to operate preset recipes; enter settings; and navigate through display.
- (H) **STOP/RESET KEYPAD**
Interrupts operation, and/or exits modes and menus.
- (I) **START/OK KEYPAD**
Begins cooking in Manual Time Entry Mode. Restarts an interrupted cooking cycle. Used to save settings and entries.

Programming Features

STAGE COOKING

Allows operator to use up to four different cooking cycles or stages consecutively without repeated input from the operator. For example, stage cooking can be set to defrost food initially, then cook it, and then keep the food warm until serving time.

PRESET RECIPE KEYPADS

Oven can store between 10 to 100 recipes in memory. Available quantity varies based on "Digit Entry" User Option.

Note: To change Digit Entry options, see "User Options" section in this manual.

DIGIT ENTRY USER OPTION	AVAILABLE RECIPES
1 <i>Single Digit</i>	10 recipes (0-9) (10 total recipes)
01 <i>Double Digit</i>	100 recipes (00-99) (100 total recipes)
1 <i>Folders</i>	10 folders (0-9) ↳ 10 recipes per folder (0-9) (100 total recipes)

QUANTITY PROMPT *(select models)*

Note: Only available when factory option ALLOW QUANTITY PROMPT is enabled and Quantity Prompt is enabled in User Options

Allows operator to select preset recipe keypad(s) for a menu item, followed by the quantity of items to be heated. Cook times and settings can be customized for each recipe in quantities 1-9.

MID-CYCLE COOKING PAUSE *(optional)*

The 'Mid-Cycle Cooking Pause' feature is designed to stop halfway through a recipe cook sequence. This pause can be used to add ingredients; check cooking progress; or stir/rotate food during the cooking cycle.

During a mid-cycle cooking pause, the oven beeps continuously and PAUSED screen will display. To continue the cycle, open and close door, and press START/OK keypad

Clean Filter Reminder

(optional)

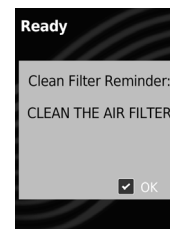

This oven displays "Clean Filter Reminder" at user defined intervals. When the message displays, ACP recommends cleaning the air filter thoroughly. Complete steps to

"Clean Air Filter" on page 24.

Cleaning the air filter will not shut off the message. The message will automatically stop displaying after 24 hours. To clear the message, press START/OK keypad.

Air filters and vents must be cleaned regularly to prevent overheating of oven. Depending on oven use and environmental conditions, the filter may need to be cleaned more frequently. Once the frequency is determined, set the user option for the appropriate time frame.

Note: To adjust frequency of Clean Air Filter Reminder, see "User Options" section in this manual.

Methods of Cooking & Programming

COOKING WITH PRESET RECIPE KEYPADS

Allows operator to quickly activate saved cooking sequences using 1-2 keypad strokes

MANUAL COOKING

Allows operator to heat without changing the preset recipe keypads

MANUALLY EDIT/CREATE NEW PRESET RECIPES

Allows operator to use keypads to edit preset recipes and/or create new recipes for customized cooking

USB MENU IMPORT AND EXPORT

Allows operator to import and export recipe settings and user options using a standard USB flash drive

ACP PROGRAMMING APPLICATION

Allows operator to create and edit recipe settings and user options on a computer.

For detailed instructions, please visit: www.acpsolutions.com/oven-programming

General Oven Screens

STANDBY



DOOR OPEN

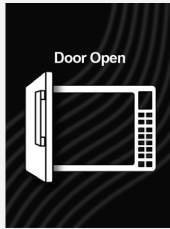

READY SCREENS

Indicates oven is ready to operate. The operator may press keypads to begin preset recipes or MENU () keypad for more options.

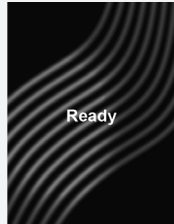

Quantity X2 disabled



Quantity X2 enabled

Menu Screens

Press MENU () keypad to access list of menu features and functions.

To scroll between pages: Press UP/DOWN (▲▼) keypads.

To access features, press corresponding number keypad.

Note: If PIN Code is enabled, your unique 4 digit pin code will be required to access MENU screen

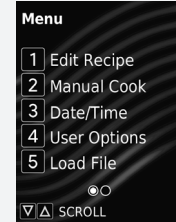

MENU
Page 1 of 2

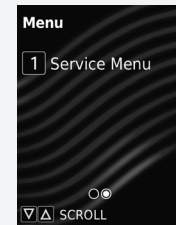

MENU
Page 2 of 2

"Menu" Page 1

- (1) **EDIT RECIPE**
Allows the operator to edit or create new preset recipes/folders for customized cooking.
- (2) **MANUAL COOK**
Allows the operator to heat without changing the preset recipe keypads.
- (3) **DATE/TIME**
Allows the operator to set Date and Time settings for their local time.
- (4) **USER OPTIONS**
Allows the operator to customize various oven settings.
- (5) **LOAD FILE**
Allows the operator to import and export recipe settings and user options using a standard USB flash drive.

"Menu" Page 2

- (1) **SERVICE MENU**
Allows authorized service technicians to access usage data, troubleshoot, and update firmware.
Note: Service PIN code required for access.



Interrupt Operation

Press STOP/RESET keypad to interrupt operation. Display continues to show countdown time. Close door and press START/OK keypad to resume oven operation.



Cancel Mistakes

If oven is not cooking, press STOP/RESET keypad to clear display. If oven is cooking, press STOP/RESET keypad twice to stop and clear display.



Set Date and Time

This oven maintains a data log which is used to diagnose and troubleshoot errors.

An accurate date and time are important for the data log.

To set date and time, from READY or DOOR OPEN screen:

1. Press MENU () keypad.
 - If prompted, enter PIN Code and press START/OK keypad.
 - MENU screen will display.
2. Press number "3" keypad to access "Date/Time".
 - DATE AND TIME screen will display.
3. **To edit date and time fields:** Press corresponding number keypad.
 - Active editable field is highlighted in red.
 - Editable fields include:
 - (1) Day
 - (2) Month
 - (3) Year
 - (4) Hours
 - (5) Minutes
 - (6) AM/PM/24
4. Press UP/DOWN (▲▼) keypads to scroll to correct setting per field.
5. **To save and exit:** Press START/OK keypad.
6. **To discard changes:** Press STOP/RESET keypad.

Operating Preset Recipe Keypads

This oven can store up to 10 or 100 recipes in memory. To heat using a preset recipe, press number keypad(s). Oven will start to heat automatically.

From READY or DOOR OPEN screen:

1. Open oven door, place food in oven, and close oven door.
 - READY screen is displayed.
2. Press desired number keypad(s):
 - **Single Digit Keypad Cooking:** Press a single keypad (0-9).
 - **Double Digit Keypad Cooking:** Press two keypads, in order, of the double digit number for the desired recipe (00-99).
 - **Folders:** Press one keypad to open folder (0-9), followed by keypad for desired recipe (0-9).

Note: To change Digit Entry option see "User Options" section in this manual
3. Oven operates and time counts down.
 - Display shows recipe name and counts down cooking time.
4. At the end of the cooking cycle, the oven beeps. Carefully remove food from oven.

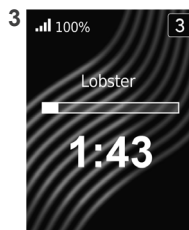
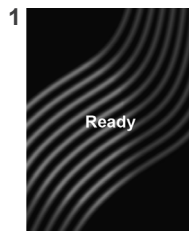

FACTORY PRESET RECIPES

KEYPAD	TIME	POWER
1	10 sec.	100%
2	20 sec.	
3	30 sec.	
4	45 sec.	
5	1:00 min.	
6	1:30 min.	
7	2:00 min.	
8	3:00 min.	
9	4:00 min.	
0	5:00 min.	

Factory setting may vary by model

+ X2 Quantity Cooking (optional)

1. Press X2 QUANTITY (+) keypad to toggle double quantity cooking feature ON.
 - "X2" appears at top center of screen when enabled.
2. Press desired number keypad(s).
 - Display shows the recipe name and counts down cooking time.
 - "X2" is displayed before the recipe name.
3. X2 automatically toggles OFF after each cooking cycle ends.

Operating Preset Recipe Keypads with Quantity Prompt (select models)

Allows operator to select preset recipe keypad(s) for a menu item, followed by the quantity of items to be heated (1-9).

1. Press desired number keypad(s).
 - ENTER QUANTITY screen is displayed.
2. Enter desired quantity using keypad 1-9.
 - Display shows the recipe name and counts down cooking time.
 - Quantity is displayed before the recipe name. (X1, X2, X3, etc.)

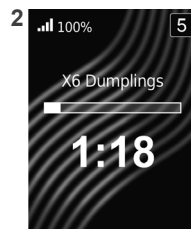
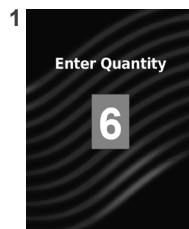

Manual Cook Screens

MANUAL COOK ENTRY

Displays while operator is entering cook settings in Manual Cook mode.
Active editable field is highlighted in red.
To navigate to editable fields: Press UP/DOWN (▲▼) keypads.

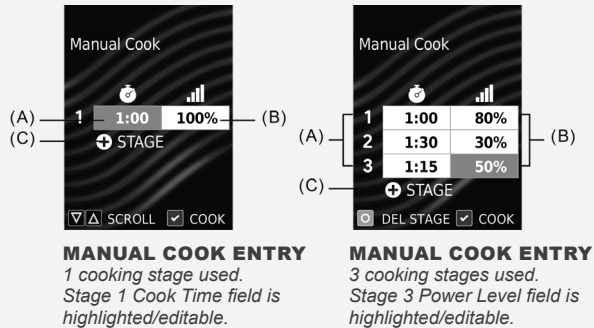

"Manual Cook" Editable Fields:

- (A) **COOK TIME (PER STAGE)**
Combined total cook time cannot exceed 60:00.
- (B) **%MICROWAVE POWER LEVEL (PER STAGE)**
Percent microwave power from 0-100% in 10% increments (keypad "0" = 0%, keypad "1"=10%, keypad "2"=20%,etc.)
For 100% power level, press any number keypad twice.
- (C) **ADD A STAGE**
Up to four stages can be entered.

2 Manual Cooking

Allows operator to heat without changing the preset recipe keypads.
From READY or DOOR OPEN screen:

1. Open oven door, place food in oven, and close door.
 - READY screen will display.
2. Press MENU () keypad.
 - If prompted, enter PIN Code and press START/OK keypad.
 - MENU screen will display.
3. Press number "2" keypad to access "Manual Cook".
 - MANUAL COOK ENTRY screen will display.
4. **To navigate to editable fields:** Press UP/DOWN (▲▼) keypads.
 - Active editable field is highlighted in red.
 - Editable fields include:
 - Cook Time (per stage)
 - %Microwave Power Level (per stage)
 - Add a Stage
5. Press number keypads to enter desired settings per field.
6. **To add additional cooking stages:** Press DOWN (▼) keypad until "+ STAGE" is highlighted.
 - A new row of Cook Time and %Microwave Power Level fields will display
 - Repeat steps 4–6 for each additional stage.
7. Press START/OK keypad to begin cooking.
 - Oven operates and display counts down cooking time.
8. At the end of the cooking cycle, the oven beeps. Carefully remove food from oven.

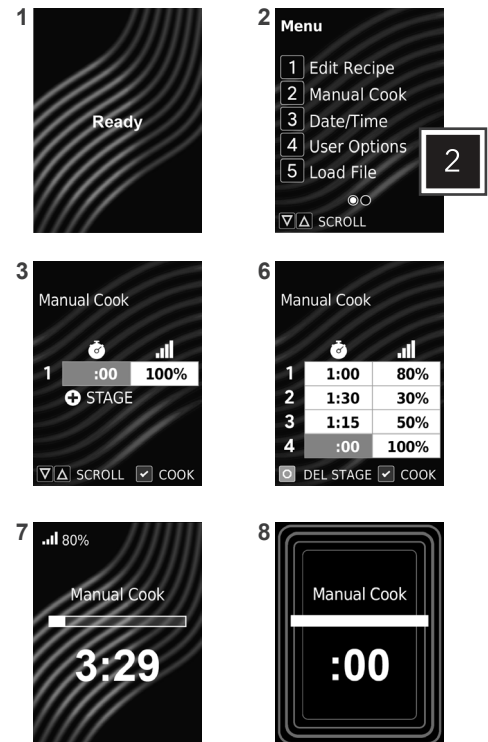

STYLE 1 Edit Recipe Screens

Edit Recipe List Screens

Indicates oven is entering "Edit Recipe" mode. The operator may press keypads to open recipe and/or folder locations.

Note: Screens may vary based on Digit Entry option in "User Options"

(A) RECIPE/FOLDER LOCATIONS

Numbers represent programmed recipes and available memory locations. Unused locations are labeled "- Available." Operator may press keypad(s) to view and edit locations.

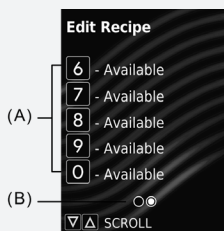

EDIT RECIPE LIST
Single Digit Entry.
Page 2 of 2 shown.

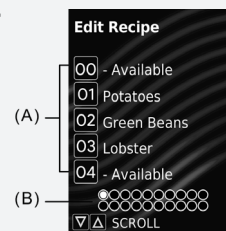

EDIT RECIPE LIST
Double Digit Entry.
Page 1 of 20 shown.

(B) MULTIPLE PAGES

Radio button icons indicate page number. Operator may press UP/DOWN (▲▼) keypads to scroll between pages.

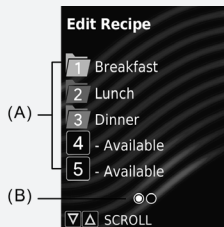

EDIT RECIPE LIST
Folders Digit Entry.
Top level.
Page 1 of 2 shown.

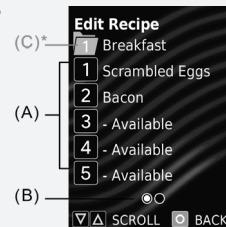

EDIT RECIPE LIST
Folders Digit Entry.
Folder 1 is open with contents shown.
Page 1 of 2 shown.

(C) PARENT FOLDER LOCATION

If folder location is opened, the contents of the selected folder are displayed. Parent folder location is displayed above the first recipe on each page.

Edit Recipe Entry Screens

Displays while a recipe or folder location is open. Stored location is represented by number at top right corner of screen. Active editable field is highlighted in red. To navigate to editable fields, press UP/DOWN (▲▼) keypads.

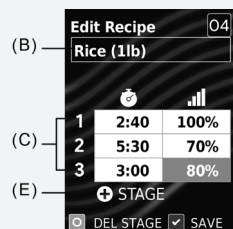

EDIT RECIPE ENTRY
Double Digit Entry.
Recipe Location "04" shown.
Stage 3 Power Level field is highlighted/editable.

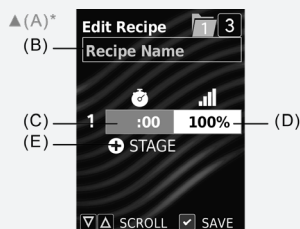

EDIT RECIPE ENTRY
Folders Digit Entry.
Recipe Location "3" within Folder "1" shown.
Stage 1 Cook Time field is highlighted/editable.

"Edit Recipe Entry" Editable Fields:

- (A) **MAKE FOLDER/ FOLDER NAME***
See "Edit Recipe Mode: Folders" on page 14 for details.
- (B) **RECIPE NAME**
See "Edit Name Screens" section.
- (C) **COOK TIME (PER STAGE)**
Combined total cook time cannot exceed 60:00.
- (D) **%MICROWAVE POWER LEVEL (PER STAGE)**
Percent microwave power from 0-100% in 10% increments (keypad "0" = 0%, keypad "1"=10%, keypad "2"=20%,etc.) For 100% power level, press any number keypad twice.
- (E) **ADD A STAGE**
Up to four stages can be entered.

Edit Name Screens

Displays while editing name of recipe or folder*. Operator may press number keypads to enter a name. To cycle through available characters: Press same keypad within 1 second.

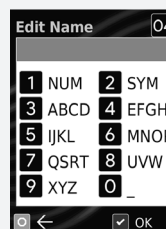

EDIT RECIPE NAME
Double Digit Entry.
Location "04" shown.

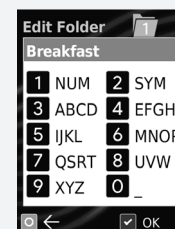

EDIT FOLDER NAME*
Folders Digit Entry.
Location "1" shown.

"Edit Name" Keypad Functions

KEYPAD	DESCRIPTION	TEXT FUNCTION
1	NUM	1234567890
2	SYM	.,&!?'()/~@#%\$^*~.+
3	ABCD	ABCdabcd
4	EFGH	EFGHefgh
5	IJKL	IJKljk
6	MNOP	MNOpmnop
7	QRST	QRStqrst
8	UVW	UVWuvw
9	XYZ	XYZxyz
0	_	(space)
START	OK	(save and exit)
STOP	<-	(backspace)

* Make Folder and Folder Name are only available when User Options>Digit Entry>Folders is enabled and location is in top level (0-9) of Edit Recipe List. See page 14 for details.

1 Edit or Create New Recipes

Allows the operator to edit or create new preset recipes/folders for customized cooking. This oven can be programmed to store up to 10 or 100 preset recipes in memory.

From READY or DOOR OPEN screen:

- Press MENU () keypad.
 - If prompted, enter PIN Code and press START/OK keypad.
 - MENU screen will display.
- Press number "1" keypad to access "Edit Recipe".
 - EDIT RECIPE LIST screen is displayed with list of preset recipes, folders, and/or available locations.
 - To scroll between pages of recipes: Press UP/DOWN (▲▼) keypads.
- Press number keypad(s) to open the desired recipe/folder location.
 - EDIT RECIPE ENTRY screen will display.
- To navigate to editable fields:** Press UP/DOWN (▲▼) keypads.
 - Active editable field is highlighted in red.
 - Editable fields include:
 - Make Folder and Folder Name*
 - Recipe Name
 - Cook Time (per stage)
 - % Microwave Power Level (per stage)
 - Add a Stage
- Press number keypads to enter desired settings per field.
- To add additional cooking stages:** Press DOWN (▼) keypad until "+ STAGE" is highlighted.
 - A new row of Cook Time and % Microwave Power Level fields will display.
 - Repeat steps 4–6 for each additional stage.
- To save and exit:** Press START/OK keypad.
- To discard changes:** Press STOP/RESET keypad.

* Make Folder and Folder Name are only available when User Options>Digit Entry>Folders is enabled and location is in top level (0-9) of Edit Recipe List. See page 14 for details.

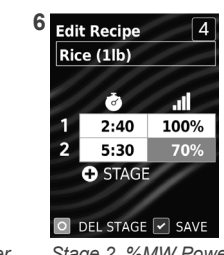
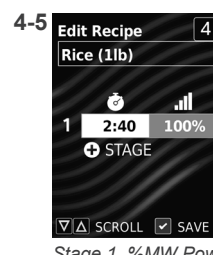
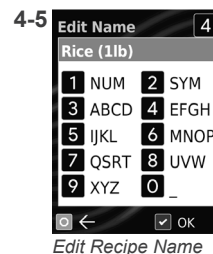
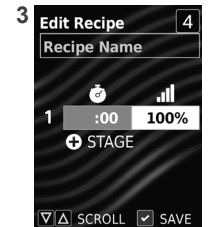
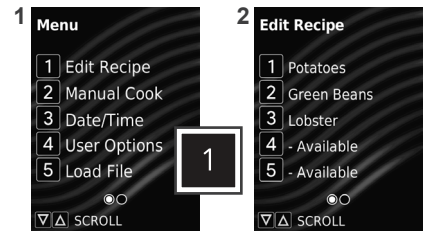

Edit or Create New Recipes with Quantity Prompt (select models)

Cook times and settings can be customized for each recipe in quantities 1-9.

To edit the settings of a specific recipe/quantity:

- Complete steps 1–3 in "Edit or Create New Recipes".
 - ENTER QUANTITY screen is displayed.
- Enter desired quantity using keypad 1-9.
 - EDIT RECIPE ENTRY screen will display.
 - Quantity is displayed before the recipe name. (X1, X2, X3, etc.)
- Complete steps 4–7 in "Edit or Create New Recipes".

Edit 'Cook factor' for X2 Quantity Cooking

The 'X2 Quantity Cooking' feature allows a percentage of original cook time, called a **cook factor**, to be added to a preset recipe. Each preset recipe can be customized with a unique cook factor. The factory default cook factor is 80%.

To adjust the cook factor for a recipe: Open the menu file in the ACP Programming Application; and adjust "Edit X2 Cook Factor" value for the desired menu item.

See page 15 to export/import menu, and open menu in ACP Programming Application.

Set a Mid-Cycle Pause

The 'Mid-Cycle Cooking Pause' feature is designed to stop halfway through a recipe cook sequence.

This pause can be used to add ingredients; check cooking progress; or stir/rotate food during the cooking cycle. Each preset recipe may be customized with a mid-cycle cooking pause. To add a pause to the middle of a recipe cook sequence: Open the menu file in the ACP Programming Application; and select "Pause mid-cycle" for the desired menu item.

See page 15 to export/import menu, and open menu in ACP Programming Application.

STYLE 1 Edit Recipe Mode: Folders

Allows operator to organize recipes in folders. Folders can only be located in the top level (0-9) of EDIT RECIPE LIST. Folders cannot be created within folders.

Note: Folders must first be enabled in User Options>Digit Entry>Folders.

Create New Folders

1. Press MENU () keypad.
2. Press number "1" keypad to access "Edit Recipe".
 - EDIT RECIPE LIST screen will display.
 - To scroll between pages of recipes: Press UP/DOWN (▲▼) keypads.
3. Press a number keypad to open the desired recipe/folder location.
 - EDIT RECIPE ENTRY screen will display.
4. Press UP (▲) keypad to navigate to Recipe Name field.
 - EDIT RECIPE NAME screen will display.
5. **To make folder:** Press UP(▲) keypad to access MAKE FOLDER screen.
 - MAKE FOLDER screen will display.
 - Press START/OK keypad to make folder.
 - EDIT FOLDER NAME screen will display.
6. **To enter folder name:** Press number keypads to enter folder name.
7. **To save folder:** Press START/OK keypad.
 - Folder will now be visible on EDIT RECIPE LIST screen.

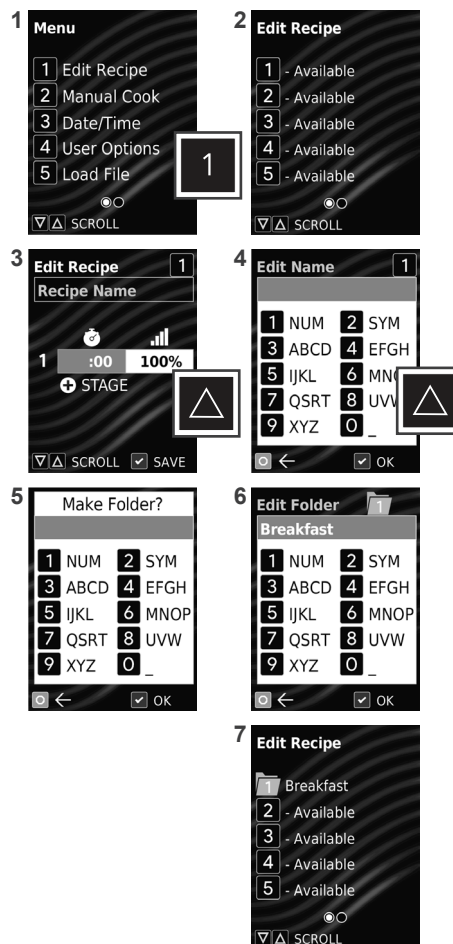

Navigate Existing Folders

From EDIT RECIPE LIST screen:

- **To open folder:** Press number keypad to open the desired folder.
- **To exit folder:** Press STOP/RESET keypad.

Edit or Create New Recipes Within Folders

1. Complete steps 1–2 in "Create New Folders" section above.
2. Press a number keypad to open the desired folder location.
 - EDIT RECIPE LIST screen is displayed with contents of the selected folder.
 - Parent folder location is displayed above the first recipe on each page.
 - To scroll between pages of recipes: Press UP/DOWN (▲▼) keypads.
3. Press a number keypad to open the desired recipe location within the folder.
 - EDIT RECIPE ENTRY screen is displayed, with parent folder location displayed to the left of the current recipe location.
4. To create recipe: Complete steps 4–7 in "Edit or Create New Recipes" on page 13.

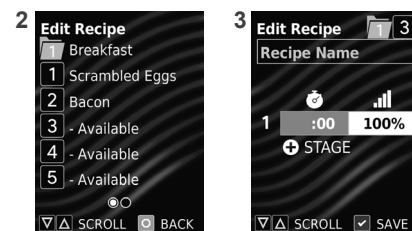

Edit Folder Name

From EDIT RECIPE LIST screen:

1. Press and hold number keypad of corresponding folder.
 - EDIT FOLDER NAME screen will display.
2. Press number keypads to edit folder name.
3. To save changes and exit folder: Press START/OK keypad.

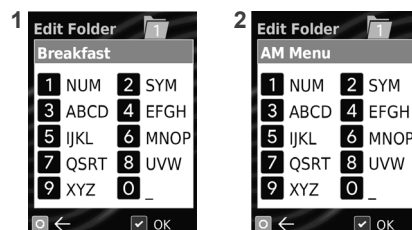

Delete Folder

Caution: Deleting a folder will make its contents inaccessible.

From EDIT RECIPE LIST screen:

1. Press and hold number keypad to corresponding folder.
 - EDIT FOLDER NAME screen will display.
2. Press UP (▲) keypad.
 - DELETE FOLDER screen is displayed.
3. To delete folder: Press START/OK keypad.
4. Press START/OK keypad again to exit EDIT RECIPE NAME screen.
5. To save changes and exit: Press START/OK keypad.

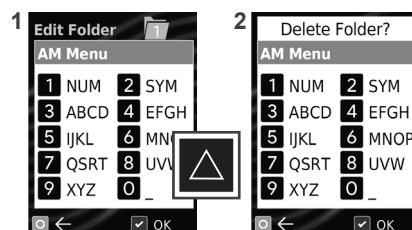



5

Import Menu from USB Flash Drive

Note: Menu file must be .XML format. Menu file must be saved at the root directory of the flash drive, and cannot be located inside any folders.

- Flip open USB port protective cover. Insert flash drive into the USB port.
- Press MENU () keypad.
 - If prompted, enter PIN Code and press START/OK keypad.
 - MENU screen will display.
- Press number "5" keypad to access "Load File".
 - LOAD FILE screen displays with list of .XML files on the root directory of the flash drive, and an option to "Export to USB".
 - If more than 4 recipes files are on the flash drive: Press UP/DOWN (▲▼) keypads to scroll through pages of files.
- To load a file: Press corresponding number keypad.
 - If upload was successful: "Loaded OK" will display. Settings and menu items will be loaded on the oven.
 - If upload failed: "Error Loading" will display.
- Press STOP/RESET keypad to exit. Remove USB Flash Drive.

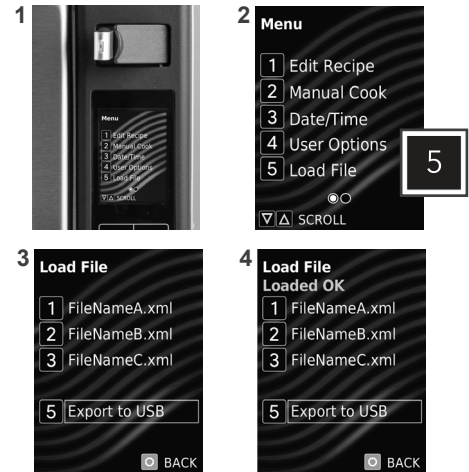

TROUBLESHOOTING:

USB flash drive must be inserted prior to selecting "Load File."

- Press STOP/RESET keypad to exit LOAD FILE screen. Insert flash drive and retry transfer.
 - If the error persists: Open USB flash drive on computer and verify that menu file is in .XML format and saved in the root directory of the flash drive. Retry transfer.
 - If the error persists: Unplug oven from outlet and plug-in oven. Retry transfer.



5

Export Menu to USB Flash Drive

- Flip open USB port protective cover. Insert flash drive into the USB port.
- Press MENU () keypad.
 - If prompted, enter PIN Code and press START/OK keypad.
 - MENU screen will display.
- Press number "5" keypad to access "Load File".
 - LOAD FILE screen displays with list of .XML files on the root directory of the flash drive, and an option to "Export to USB".
 - If more than 4 recipes files are on the flash drive: Press UP/DOWN (▲▼) keypads to scroll through pages of files.
- Press number "5" keypad to access "Export to USB". Oven will begin to export to USB flash drive.
 - If export was successful: "Export OK" will display. Settings, menu items, and oven usage data will be loaded on USB Flash Drive.
 - If export failed: "Export Failed" will display.
- Press STOP/RESET keypad to exit. Remove USB Flash Drive.



TROUBLESHOOTING:

USB flash drive must be inserted prior to selecting "Export to USB."

- Insert flash drive and retry transfer.



ACP Programming Application

For larger, and more complex menus, it may be more manageable to create and edit menus using the ACP Programming Application. For detailed instructions, please visit: www.acpsolutions.com/oven-programming/

OPEN MENU IN ACP PROGRAMMING APPLICATION

Note: For more details, please see ACP Programming Application User Guide online

- Insert flash drive into USB port on computer.
- Open ACP Programming Application.
- Select "File", "Open." Navigate to flash drive. Select and open menu file (.XML format).

Update Firmware

Note: Firmware files must be loaded on USB flash drive. Must be saved at the root directory of the flash drive, and cannot be located inside any folders.

- Flip open USB port protective cover. Insert flash drive into the USB port.
- Press MENU () keypad.
- Press DOWN (▼) keypad to scroll to second page of MENU.
- Press number "4" keypad to access "Service Menu".
 - PIN Code prompt appears.
- Press keypads 1-3-5-7-9 to enter SERVICE MENU.
- Press and hold number "7" keypad for 3 seconds to initiate firmware update.

TROUBLESHOOTING:

If firmware fails to load: Press and hold STOP/RESET keypad while plugging in the oven.

There are several options you can change to customize the operation of the oven. Options are shown below. The **factory setting is shown in bold type**.

4 Access and Modify User Options

- Press MENU () keypad.
 - If prompted, enter PIN Code and press START/OK keypad.
 - MENU screen will display.
- Press number "4" keypad to access "User Options".
 - USER OPTIONS screen will display with list of customizable settings.
 - To scroll between pages of settings: Press UP/DOWN (▲▼) keypads.
- To access available options for a setting: Press corresponding number keypad.
 - The currently selected option is highlighted in red.
- To change a setting: Press corresponding number keypad.
 - The newly selected option is highlighted in red.
- To save changes:** START/OK keypad.
- To exit:** Press STOP/RESET keypad.

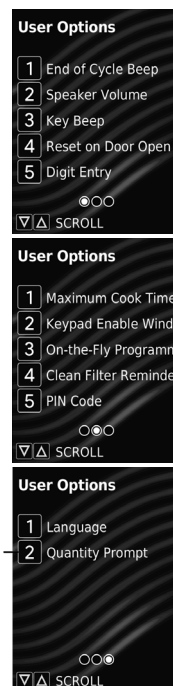

STANDARD DEFAULT PER MODEL (FACTORY SETTINGS IN BOLD)

Factory setting may vary by model

SETTING	DISPLAYED OPTIONS	DESCRIPTION
End of Cycle Beep	3 Seconds Continuous Burst	3 second continuous beep. Continuous beep until door is opened. 5 beep bursts until door is open.
Speaker Volume	Off Low Medium High	Sets volume to off. Sets volume to low. Sets volume to medium. Sets volume to high.
Key Beep	Off On	Prevents beep when keypad is pressed. Allows beep when keypad is pressed.
Reset on Door Open	End Cook Cycle Pause Cook Cycle	Cancels heating time count down after door is opened during cycle. Allows oven to resume heating time countdown after door is opened during cycle.
Digit Entry	Single Digit Double Digit Folders	Allows 10 (0-9) preprogrammed recipes. Allows 100 (00-99) preprogrammed recipes. Allows 10 folders (0-9), each with 10 preprogrammed recipes.
Maximum Cook Time	10 minutes 60 minutes	Allows 10 minutes of heating time. Allows 60 minutes of heating time.
Keypad Enable Window	15 seconds 30 seconds 1 minute 2 minutes	15 seconds after oven door is opened, keyboard disabled. 30 seconds after oven door is opened, keyboard disabled. 1 minute after oven door is opened, keyboard disabled. 2 minutes after oven door is opened, keyboard disabled.
On-the-Fly Programming	Off On	Disables pushing any additional keypads during a cook cycle. Allows pushing additional keypads to add or change time in the middle of a cook cycle.
Clean Filter Reminder	Off Every 7 Days Every 30 Days Every 90 Days	Oven will not display "Clean Filter Message". Oven will display "Clean Filter Message" every 7 days. Oven will display "Clean Filter Message" every 30 days. Oven will display "Clean Filter Message" every 90 days.
PIN Code	Off On Set PIN Code	PIN Code not required to access Menu or User Options. PIN Code required to access Menu and User Options. PIN Code required. Create new 4 digit PIN Code.
Language	Chinese (Mandarin), Danish, Dutch, English , Filipino, French, German, Greek, Italian, Japanese, Korean, Norwegian, Polish, Portuguese, Romanian, Russian, Spanish, Swedish, Ukrainian, Vietnamese	
Quantity Prompt**	On Off	Prompts the user for portion quantity multiplier (1-9) upon selecting a preset recipe. Allows user to cook individual portions, and/or use X2 Quantity multiplier feature.

** Available on select models only. (Only displayed in User Options menu if factory option is enabled)

STYLE 2

Oven & Control Panel Features

Note: There are multiple styles of controls. Choose the control that matches unit.
Control panel branding and coloring may vary by model

Oven Features

- (1) **TOP CONTROL PANEL**
- (2) **DISPLAY**
- (3) **SIDE CONTROL PANEL**
- (4) **AIR INTAKE FILTER** *(not pictured)*
Removable and cleanable air intake filter.
- (5) **DOOR HANDLE**
Ergonomically designed for one handed "Lift and Pull" operation.
- (6) **UNIT SERIAL NUMBER** *(not pictured)*
Located inside the door and on the lower-right-side of the oven.

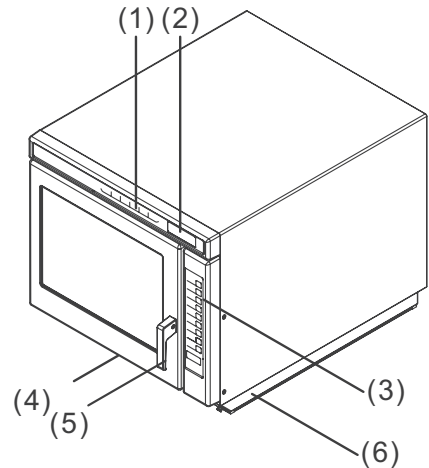

Control Panel Features

TOP CONTROL PANEL

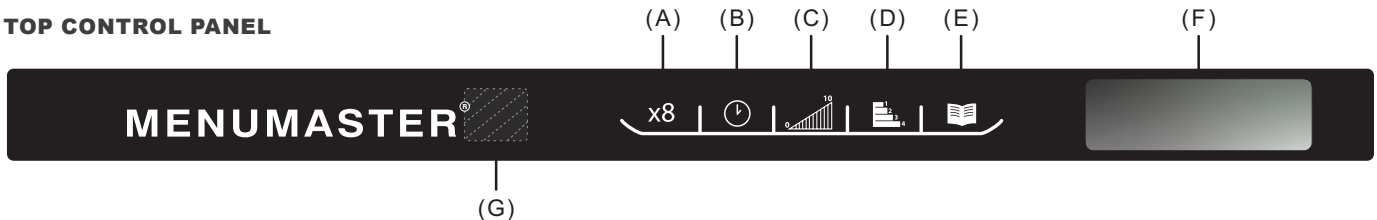

- (A) **X8 QUANTITY KEYPAD**
Increases a preset cook time by adding a percentage of the original cook time, also known as a **cook factor**. Used for cooking multiple servings of foods. Quantity can be increased up to 8 times.
- (B) **TIME ENTRY KEYPAD**
Use to enter cooking time for either manual entry or programming modes.
- (C) **POWER LEVEL KEYPAD**
Use to set microwave power level between 0% to 100% in 10% increments (keypad "0" = 0%, keypad "1"=10%, keypad "2"=20%,etc.). For 100% power level, press any number keypad twice.
- (D) **STAGE KEYPAD**
Use in manual cooking and/or programming modes to add additional cooking stages. Up to four stages can be entered.
- (E) **PROGRAM SAVE KEYPAD**
Use to access, create, edit, and save settings for preset cooking programs and user options.
- (F) **DISPLAY**
LED-backlit LCD.
- (G) **HIDDEN KEYPAD**
Use to access user options.

- (H) **NUMBER KEYPADS**
Used to operate preset cooking programs and enter settings.
- (I) **STOP/RESET KEYPAD**
Interrupts a cooking sequence in progress; clears out any remaining time; and also ends a programming or user option cycle. When the STOP/RESET pad is used to end a programming or option change, the changes are discarded.
- (J) **START/OK KEYPAD**
Begins cooking in Manual Time Entry Mode. Restarts an interrupted cooking cycle. Used to save settings and entries.

SIDE CONTROL PANEL

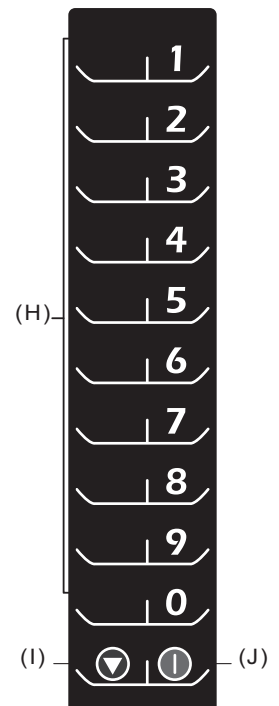

Programming Features

STAGE COOKING

Allows operator to use up to four different cooking cycles or stages consecutively without repeated input from the operator. For example, stage cooking can be set to defrost food initially, then cook it, and then keep the food warm until serving time.

PRESET PROGRAM KEYPADS (DIGIT ENTRY)

The oven can store either 10 or 100 cooking programs in memory.

A. Single Digit Keypad Cooking

From the factory, the oven is programmed to store 10 cooking programs (0-9). Each keypad begins a cooking program.

B. Double Digit Keypad Cooking

The oven control can be changed to store up to 100 cooking programs (00-99). Each entry will be assigned a double digit number, for example 01, 05, or 20. When using the double keypad programming, two keypads must be pressed to start the cooking cycle.

Note: To set control to Double Digit Entry, see "User Options" section in this manual.

MID-CYCLE COOKING PAUSE (optional)

The 'Mid-Cycle Cooking Pause' feature is designed to stop halfway through a recipe cook sequence. This pause can be used to add ingredients; check cooking progress; or stir/rotate food during the cooking cycle.

To utilize Cooking Pause, follow programming sequences for programmable pad.

Methods of Cooking & Programming

COOKING WITH PRESET PROGRAM KEYPADS

Allows operator to quickly activate saved cooking sequences using 1-2 keypad strokes

MANUAL COOKING

Allows operator to heat without changing the preset program keypads

MANUAL PROGRAMMING MODE

Allows operator to use keypads to edit preset programs and/or create new programs for customized cooking

Cooking Displays

STYLE 2	DESCRIPTION
READY	"Ready" Displays when oven control will accept entries
00:00	Displays cooking time. If stage cooking is programmed, total cooking time is displayed.
MW: 50%	"MW __%" displays the current microwave power level. 100% is the highest setting, and 0% is lowest (no microwave energy used).
ITEM-05	"ITEM-__" displays the single or double digit entry location of a programmed cooking sequence when using a programmed pad.
STAGE 1	"STAGE _" displays the stage number (1 through 4) the oven is at in the cooking sequence.
QUANTITY = 2	"QUANTITY = _" displays the number of portions (1-8) selected for Quantity Keypad cooking.

Programming Displays

STYLE 2	DESCRIPTION
ENTER PROGRAM TO ADD/REVIEW:	Displays when oven is in programming mode.
STAGE 1	Displays stage number during cooking or when programming a specific cooking stage. Stage number (1 through 4) indicates the stage that is being used.

The display is used for many different models of microwaves. Depending on the model, certain words or symbols may never be highlighted or become visible.

Example Cooking Displays

MANUAL	STAGE:1
00:50	MW:100%

MANUAL COOKING

ITEM-05	STAGE:1
01:23	MW:50%

PREPROGRAMMED ITEM

PROGRAM PAUSED Display

MID-CYCLE COOKING PAUSE

The 'Mid-Cycle Cooking Pause' feature is designed to stop halfway through a recipe cook sequence. This pause can be used to add ingredients; check cooking progress; or stir/rotate food during the cooking cycle.

During a mid-cycle cooking pause, the oven beeps continuously and PROGRAM PAUSED displays until the oven door is opened and closed again.

To continue the cooking cycle, press START/OK keypad.

Operating Preset Program Keypads

This oven can store up to 10 or 100 cooking programs in memory. To heat using a preset recipe, press number keypad(s). Oven will start to heat automatically. From READY or DOOR OPEN screen:

1. Open oven door, place food in oven, and close door.
 - "READY" will display.
2. Select the keypad(s) for the desired preprogrammed cooking sequence.
 - **Single Digit Keypad Cooking:** Press a keypad (0-9)
 - **Double Digit Keypad Cooking:** Press two keypads, in order, of the double digit number for the desired cooking sequence.(00-99)
3. Oven begins cooking and displays program item number, stage, percentage of microwave power, and total cooking time.
4. At the end of the cooking cycle, the oven beeps. Carefully remove food from oven.

FACTORY PRESET RECIPES

KEYPAD	TIME	POWER
1	10 sec.	100%
2	20 sec.	
3	30 sec.	
4	45 sec.	
5	1:00 min.	
6	1:30 min.	
7	2:00 min.	
8	3:00 min.	
9	4:00 min.	
0	5:00 min.	

Factory setting may vary by model

x8

X8 Quantity Keypad Cooking

To increase cooking time when cooking more than one serving.

1. Open oven door and place food in oven. Close door.
 - "READY" will display.
2. Press X8 QUANTITY keypad.
 - Keypad can be pressed repeatably to add additional portions (quantities 1-8)
 - Amount of time added is a percentage of the original preset cooking time.
 - The percentage (**Cook factor**) can be changed. See Programming section in this manual.
3. Select the keypad(s) for the desired preprogrammed cooking sequence.
 - **Single Digit Keypad Cooking:** Press a keypad (0-9)
 - **Double Digit Keypad Cooking:** Press two keypads, in order, of the double digit number for the desired cooking sequence.(00-99)
4. Oven begins cooking and displays remaining cooking time.
 - Display shows the program item number, stage, percentage of microwave power, and the total cooking time for multiple quantities.

Manual Cooking Mode

Allows operator to heat without changing the preset program keypads.

From READY or DOOR OPEN screen:

1. Open oven door, place food in oven, and close door.
 - "READY" will display.
2. **To enter Cooking Time:** Press TIME ENTRY keypad.
 - Press number keypads to enter cook time.
3. **To edit Power Level:** Press POWER LEVEL keypad.
 - Press number keypads to enter % microwave power ("0"=0%, "1"=10%, "2"=20%, etc.).
 - For 100% microwave power level, press any number keypad twice.
4. **To add additional cooking stages:** Press STAGE keypad.
 - Repeat steps 2-4 for each additional stage.
 - Up to four stages can be entered.
5. Press START/OK keypad to begin cooking.
 - Oven operates and display counts down cooking time.
6. At the end of the cooking cycle, the oven beeps. Carefully remove food from oven.

Programming Mode

Allows operator to assign cook times, power levels, and stage cooking to the number keypads.

From READY or DOOR OPEN screen:

1. Press PROGRAM SAVE keypad.
 - Programming mode begins.
 - "Enter Program to Add/Review:" will display.
2. Select the keypad(s) to change or review the program cooking sequence.
 - **Single Digit Keypad Cooking:** Press a keypad (0-9).
 - **Double Digit Keypad Cooking:** Press two keypads, in order, of the double digit number for the desired cooking sequence (00-99).
3. **To enter Cooking Time:** Press TIME ENTRY keypad.
 - Press number keypads to enter cook time.
4. **To edit Power Level:** Press POWER LEVEL keypad.
 - Press number keypads to enter % microwave power ("0"=0%, "1"=10%, "2"=20%, etc.).
 - For 100% microwave power level, press any number keypad twice.
5. **To add additional cooking stages:** Press STAGE keypad.
 - Repeat steps 3-5 for each additional stage.
 - Up to four stages can be entered.
6. **To save the cooking program:** Press PROGRAM SAVE keypad.
7. **To discard changes:** Press STOP/RESET keypad.

x8

Quantity Keypad Programming

This feature allows a percentage of original cook time, called a **cook factor**, to be added to a programmed cook sequence. Each time the quantity keypad is pressed, the cooking time is increased by the user-specified percentage.

Each programmed cook sequence may be customized with a unique cook factor.

Note: The factory default cook factor is 80%. Cook factors may vary by model.

TO EDIT THE COOK FACTOR:

1. Complete steps 1-5 in "Programming Mode" section.
2. Select the keypad(s) to reprogram.
3. Press QUANTITY (X8) keypad.
 - Default of CF:80 displays.
 - Press number keypads to enter desired cook factor ("0"=0%, "1"=10%, "2"=20%, etc.)
4. To save the cooking program: Press PROGRAM SAVE keypad.

SET A MID-CYCLE PAUSE

To add a pause to the middle of a programmed cook sequence.

While in Programming Mode, after entering Cooking Time or Power Level:

1. Press HIDDEN keypad.
 - A short beep sounds. This indicates the program is set for a mid-cycle pause.
2. Continue programming as desired.

When preset program keypad is used, pause will occur in the middle of total programmed time. The oven beeps continuously and PROGRAM PAUSED displays until the oven door is opened and closed again. To continue the cooking cycle, press START/OK keypad.

There are several options you can change to customize the operation of the oven. Options are shown below. The **factory setting is shown in bold type**.



Access and Modify User Options

From READY screen:

1. Press HIDDEN keypad.
 - Hidden keypad is unmarked.
 - Nothing will be displayed when hidden keypad is pressed.
2. Press PROGRAM SAVE keypad.
 - The first user option will display. Oven is now in options mode.
3. Press number keypad that corresponds to setting.
 - See table below for keypads/settings/options.
 - Setting and the currently selected option will display.
4. Press numeric keypad again to toggle through list of options for the keypad/setting.
 - Each time keypad is pressed, the displayed option will change.
 - Changes take affect after keypad is pressed.
 - Press PROGRAM SAVE keypad to save changes.
5. Press STOP/RESET keypad to exit, or open and close oven door.

STANDARD DEFAULT PER MODEL (FACTORY SETTINGS IN BOLD)

Factory setting may vary by model

KEYPAD	SETTING	DISPLAYED OPTIONS	DESCRIPTION
1	Double Digit Entry	Disabled Enabled	Allows 10 (0-9) preprogrammed pads. Allows 100 (00-99) preprogrammed pads.
2	Manual Programming	Disabled Enabled	Manual time entry/cooking not allowed. Manual time entry/cooking allowed.
3	Reset on Door Open	Disabled Enabled	Opening oven door does not reset oven back to ready mode. Opening oven door does resets oven back to ready mode.
4	Keybeep	Off On	Keys do not beep when pressed. Keys beep when pressed.
5	Speaker Volume	Off Low Medium High	Keybeep volume OFF. Keybeep volume LOW. Keybeep volume MEDIUM. Keybeep volume HIGH.
6	End of Cook Signal	Solid Beep 3 Second Beep 4 Beeps Once 4 Beeps Repeating	Food done signal is a continuous beep until reset by user. Food done signal is a three second beep. Food done signal is four beeps, once. Food done signal is four beeps, four times.
7	Keypad Active	15 seconds 30 seconds 60 seconds 120 seconds Always	Keypad time entry window is 15 seconds. Keypad time entry window is 30 seconds. Keypad time entry window is one minute. Keypad time entry window is two minutes. Keypad time entry window is always active.
0	Quantity Prompt**	Disabled Enabled	Allows user to cook individual portions and/or use quantity keypad. Prompts the user for portion quantity multiplier (1-9) upon selecting a preset program.
STAGE KEYPAD	Clean Filter Message Frequency	Disabled Weekly Monthly Quarterly	Oven will not display "Clean Filter Message". Oven will display "Clean Filter Message" every seven (7) days. Oven will display "Clean Filter Message" every thirty (30) days. Oven will display "Clean Filter Message" every ninety (90) days.

** Available on select models only. (Only displayed in User Options menu if factory option is enabled)

Cooking Instructions

Steaming Tips

COOKING VESSELS

- Always heat or cook food items in covered containers to accomplish:
 - Retention of steam for efficient cooking and to keep foods moist
 - Even cooking results and temperatures
 - A cleaner oven interior and prevention of food splatters
- Ceramic, paper, china, styrofoam, glass and plastic are suitable materials for use in microwave ovens.
- A high temperature resistant amber pan is recommended for ALL items, especially those high in fat or sugar content, as these ingredients get hot very quickly.

FOOD TEMPERATURE

- To reach a mandatory serving temperature, frozen foods require a longer cook time than refrigerated items.
- Refrigerated items:
 - Items stored at 40°F (4°C) in the refrigerator should be covered while heated; except breads, pastries or any products with a breaded coating, which should be heated uncovered to avoid softening.
- Room temperature items:
 - Foods held at room temperature, such as canned items or vegetables, will require less time to heat than refrigerated items.
- Conventionally prepared foods should be slightly undercooked to prevent overcooking when rethermed by microwave steaming.
- After a steaming cycle has been completed, internal food temperatures continue to slightly rise due to the presence of steam.

STRUCTURE OF FOOD

- Food items that are high in fat, sugar, salt and moisture attract and quickly absorb microwave energy, allowing for a shorter cook time.
- Items high in protein or fiber require a longer cook time, due to a slower absorption of microwave energy.

QUANTITY

As the mass of food increases, so will the necessary cook time.

Refer to and comply with all USDA/FDA Food Code guidelines when cooking or heating food items.

Care & Cleaning

Microwave energy is attracted to any food source in the oven. Moisture, spills, and grease can affect heating performance and may cause oven damage. To prevent damage to oven, clean oven frequently and remove any food debris. Follow the recommendations below.

⚠ CAUTION: NOT FOLLOWING APPROVED OVEN CLEANING INSTRUCTIONS MAY VOID YOUR OVEN WARRANTY.

⚠ Do NOT use abrasive cleaners or cleaners containing ammonia, citrus, phosphates, chlorine, sodium or potassium hydroxide (lye). The use of caustic cleaning products or those containing ammonia, citrus, phosphates, chlorine, sodium or potassium hydroxide (lye) can damage critical oven parts. Use of unapproved cleaning agents will void the terms of warranty.

⚠ DO NOT allow cooking residues such as grease or fat to remain in oven interior for any length of time.

⚠ Never pour water into microwave oven bottom.

⚠ Do NOT use water pressure type cleaning systems.

⚠ Do NOT operate oven without the antenna shield and air filter in place.

⚠ ALWAYS unplug oven before cleaning.

⚠ WARNING

To avoid electrical shock which can cause severe personal injury or death, unplug power cord or open circuit breaker to oven before cleaning.

Wear protective gloves and protective glasses when cleaning the oven.

Failure to maintain the oven in a clean condition could lead to deterioration of the surface that could adversely affect the life of the appliance and possibly result in a hazardous situation.

Daily Care & Cleaning

OVEN INTERIOR



1. Unplug Oven. 
2. Remove any food debris.
3. Clean microwave oven with mild detergent in warm water using soft sponge or cloth. Wring sponge or cloth to remove excess water before wiping equipment.
4. If desired, boil a cup of water in microwave oven to loosen soil before cleaning.

OVEN EXTERIOR CONTROL PANEL

5. **CLEAN EXTERIOR DOOR AND SURFACES** with a clean cloth, sponge or nylon pad; using a mild detergent and warm water solution.
 6. **CLEAN CONTROL PAD AND SCREEN** with a dry or damp microfiber cloth.
- ⚠** Do NOT use Windex or other harsh chemicals. Do NOT spray liquid on the screen.

ANTENNA/SPLATTER SHIELD

The antenna shield (or splatter/grease shield) is a vital part of the oven's design. Clean the shield in place to prevent food splatter/debris from building up on the oven ceiling.

7. Unplug Oven. 
8. Clean antenna shield with mild detergent in warm water using soft sponge or cloth. Wring sponge or cloth to remove excess water before wiping equipment.
9. **FOR STUBBORN DEBRIS**, it may be necessary to remove antenna shield for deeper cleaning.
 - a. Unplug Oven  to stop antenna from rotating.
 - b. Remove antenna shield:
 - Place fingers on front of antenna shield, push forward, and down.
 - Remove the shield by inclining at a 45 degree angle.
 - When removing and replacing antenna shield, be careful not to bend antenna.
 - c. Clean shield in warm water with mild detergent. Rinse with water.
 - ⚠** Do NOT wash antenna shield in dishwasher.
 - d. Dry thoroughly.
 - e. Reinstall antenna shield:
 - Insert antenna shield tabs into slots at top of oven cavity back.
 - Lift and press front of shield until shield snaps into place.
 - Reconnect power to oven.

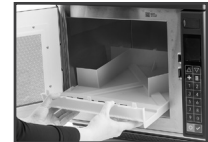

Weekly Care & Cleaning

CLEAN AIR FILTER

Filter is located below oven door. Clean air filter weekly to avoid overheating and oven damage.

10. Unplug Oven. 
- To remove air filter, turn thumbscrews counterclockwise.
- Wash filter in hot water and mild detergent. Rinse and dry thoroughly.
- To reinstall, position filter over air intake and turn thumbscrews clockwise.



Monthly Care & Cleaning

DISCHARGE AIR VENTS

Check monthly for a buildup of cooking vapors along discharge louvers on back of oven.

11. Clean air vent with damp cloth to ensure proper airflow. Dry thoroughly.

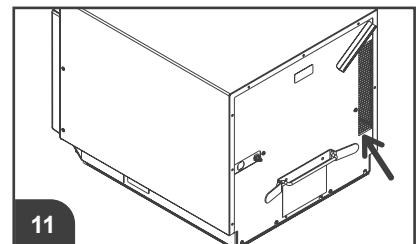

Before Calling for Service

Record all inspections and repair for future reference.

⚠ WARNING

To avoid electrical shock which can cause severe personal injury or death, do not remove outer case at any time. Only an authorized servicer should remove outer case.

OVEN STYLE	SYMPTOM	POSSIBLE CAUSE
All	Oven fan turns on while oven is not preheating or cooking.	Normal operation.
	Oven does not operate.	Confirm oven is plugged in. Check fuse or circuit breaker. Confirm oven is plugged into dedicated circuit. Confirm oven is on grounded and polarized circuit. Contact electrician to confirm.
	"CLEAN FILTER" shows in display.	This is normal and will appear for 24 hours. • Complete steps to "Clean Air Filter" on page 24. • To clear the message, Press START/OK keypad.
	If oven does not accept entries when keypad is pressed.	Make sure oven is on. Open and close oven door. Press keypad again. Check User Option>Digit Entry.
Style 1	"EXCEEDS MAXIMUM COOK TIME" shows in display.	Total cook time exceeds the maximum allowable. • Check cook times per stage. • Check User Option>Maximum Cook Time.
	"INVALID ENTRY" shows in display.	PIN Code entered is incorrect, or cook time is zero or unset. • Correct entry. Retry.
	"ERROR 5: STUCK KEY" shows in display.	A keypad is actuated continuously or there is an issue with the keypad. • Ensure the keypad is not in contact with anything. ↳ If the error persists, please call for service.
Style 2	If oven malfunctions or shows: ERROR! ERROR CODE: 1 (example)	Oven control is equipped with a self-diagnostic system. Self-diagnostic system alerts you if there is an error or problem. When electronic control signals a problem, follow steps listed below. • Record number shown. (Example: "Error Code: 1") • Unplug oven, wait for 1 minute. Plug-in oven. ↳ If code does not reappear, continue with normal use of the oven. ↳ If the error persists, please call for service. Do not use oven until contacting ComServ or ACP Authorized Servicer.
	"CALL SERVICE" shows in display (flashing after cook cycle).	Oven may not be operating at full power. Contact ComServ or ACP Authorized Servicer.

Amana® Commercial RC
Contact:



866-426-2621

MenuMaster® MRC
Contact:



866-811-8559

email: commercialservice@acpsolutions.com

For full product documentation visit:
www.acpsolutions.com